

APC™ Smart-UPS™ Ultra External Battery Pack SRTL180RM2UBP and SRTL180RM2UBPJ

Important Safety Instructions

SAVE THESE INSTRUCTIONS - This manual contains important instructions that should be followed during installation and maintenance of the Smart-UPS and batteries.



This is the “Read user manual” symbol. Read the user documentation to become familiar with the equipment.

Read these instructions carefully and look at the equipment to become familiar with the device before trying to install, operate, service or maintain it.

The following special messages may appear throughout this bulletin or on the equipment to warn of potential hazards or to call attention to information that clarifies or simplifies a procedure.



The addition of this symbol either to a “Danger” or “Warning” safety label indicates that an electrical hazard exists which will result in personal injury if the instructions are not followed.



This is the safety alert symbol. It is used to alert you to potential personal injury hazards. Obey all safety messages that follow this symbol to avoid possible injury or death.

DANGER

DANGER indicates a hazardous situation which, if not avoided, **will result in** death or serious injury.

WARNING

WARNING indicates a hazardous situation which, if not avoided, **could result in** death or serious injury.

CAUTION







CAUTION indicates a hazardous situation which, if not avoided, **could result in** minor or moderate injury.

NOTICE

NOTICE is used to address practices not related to physical injury.

Electrical equipment should be installed and operated only by qualified personnel. No responsibility is assumed by Schneider Electric for any consequences arising out of the use of this material.

Product Handling Guidelines

					
<18 kg <40 lb	18-32 kg 40-70 lb	32-55 kg 70-120 lb	>55 kg >120 lb		

Safety and General Information

- Connect only SELV circuits to all the communication ports.
- Changes and modifications to this unit not expressly approved by Schneider Electric could void the warranty.
- This External Battery Pack (XLBP) is for Professional Business Applications and not for Consumer Applications.
- This XLBP must be installed in dedicated IT environments only.

Battery Safety



WARNING

RISK OF CHEMICAL HAZARD AND EXCESSIVE SMOKE





- Replace the battery modules at least every 10 years or at the end of its service life, whichever is earlier.
- Replace the battery modules immediately when the UPS indicates battery replacement is necessary.
- Replace battery modules with the same type as originally installed in the XLBP. Failure to follow these instructions can result in death or serious injury.

- The battery module typically lasts for 10 years. Environmental factors impact the life of the battery module. Elevated ambient temperatures, poor quality utility power causing frequent short duration discharges will shorten the life of the battery module.
- Replace the Replaceable battery module (RBM) immediately if the unit indicates battery replacement is necessary.
- The XLBPs should be replaced by qualified personnel only.
- The battery modules can be replaced by the user.
NOTE: Live swap of RBM should be performed by qualified personnel only.
- If attempting to replace the battery module:
 - Use only APC RBMs.
 - Do not use third-party battery modules.
 - Replace with the same number of battery modules as originally installed in the XLBP.
- APC uses NMC chemistry Lithium Ion batteries. Under normal use and handling, there is no contact with the internal components of the battery module.
- Do not drive nails into the XLBP.
- Do not strike the XLBP with a hammer.
- Do not stand on the XLBP.
- Do not short circuit XLBP.
- Do not place or use the XLBP near heat or fire.

- Do not use a dropped, damaged or deformed XLBP.
- Do not use the XLBP to power other equipment.
- CAUTION: A battery can present a risk of electric shock and burns by high short-circuit current.
- CAUTION: Before installing or replacing the battery modules, remove conductive jewelry such as chains, wrist watches and rings. High energy through conductive materials could cause severe burns.
- CAUTION: Do not crush or dispose off the XLBP in a fire. The cells may explode.
- CAUTION: Do not open or tamper with the XLBP enclosure. Doing so will expose the cell terminals which pose an energy hazard.
- CAUTION: Do not open the battery module or mutilate the cells inside it. Released chemical is harmful to the skin and eyes. It may be toxic.
- CAUTION: Failed batteries can reach temperatures that exceed the burn thresholds for touchable surfaces.

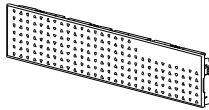
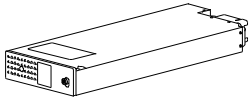
Package Contents

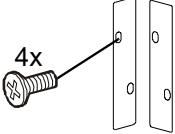
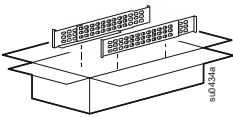
Inspect the contents upon receipt. Notify the carrier and dealer if there is damage.

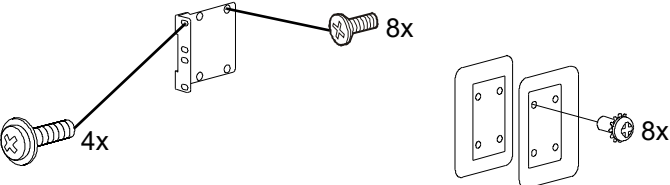
<p>Front bezel</p> 	<p>Replaceable Battery Modules (2x)</p> 
<p>Tie bracket</p>  <p>Flat head screws (2x) to secure tie brackets</p> 	<p>Stabilizer brackets (1 pair)</p>  <p>Flat head screws (4x) to secure stabilizer brackets to the UPS</p>
<p>Rail Kit with instructions and hardware for installing rails in a rack</p> 	<p>Ground cable</p>  <p>Battery communication cable</p> 
<ul style="list-style-type: none"> • Rack-mount bracket (1 pair) • Flat head screws (8x) to secure rack-mount brackets to the XLBP • Ornamental screws (4x) to secure rack-mount brackets to the rack • Cleats (1 pair) • Pan head screws (8x) to secure cleat to the XLBP 	

Specifications

For additional specifications, refer to our web site, www.apc.com.

Environmental

Temperature	Operating	0 to 40 °C (32 to 104 °F)
	Storage	-15 to 45 °C (5 to 113 °F)
Maximum Elevation	Operating	0 - 3,000 m (0 - 10,000 ft)
	Storage	0 - 15,000 m (49,212 ft)
Humidity		0% to 95% relative humidity, non-condensing
International Protection Code		IP20
NOTE:		
<ul style="list-style-type: none"> • Charge the RBMs immediately upon receipt / first installation and at least once in 9 (nine) months during storage or when not in use. • Environmental factors impact battery life. Elevated ambient temperatures, high humidity, poor quality mains power causing frequent short duration discharges, will shorten battery life. 		

Physical

The XLBP is heavy. Follow all lifting guidelines.	
Unit weight without batteries and without packaging (approx.)	12 kg (26.46 lbs)
Unit weight with batteries and with packaging (approx.)	42 kg
Unit dimensions without packaging Height x Width x Depth	86 x 432 x 724 mm (3.39 x 17.00 x 28.50 in)
Unit dimensions with packaging Height x Width x Depth	392 x 585 x 984 mm (15.43 x 23.03 x 38.74 in)
The model and serial numbers are on a small label located on the rear panel.	

Battery Module

Battery type	Lithium-Ion
Replacement battery module This UPS has replaceable battery modules. Refer to the appropriate replacement battery user manual for installation instructions. Contact your dealer or go our web site, www.apc.com for information on replacement batteries.	SRYLBM
Number of battery modules	2
Voltage of each battery module	180 V
Total voltage of the XLBP	180 V
Ah rating	4 Ah per battery module (usable: 2.47 Ah)
XLBP cable length	500 mm (19.7 in)

Battery module	UPS	XLBP
SRYLBM	SRTL5KRM2UT/SRTL5KRM2UT-HW SRTL5KRM2UI/SRTL5KRM2UI-HW SRTL8KRM4UT/SRTL8KRM4UI SRTL10KRM4UT/SRTL10KRM4UI	SRTL180RM2UBP
	SRTL5KRM2UJ/SRTL5KRM2UJ-HW SRTL8KRM4UJ/SRTL10KRM4UJ	SRTL180RM2UBPJ

Front Panel Features

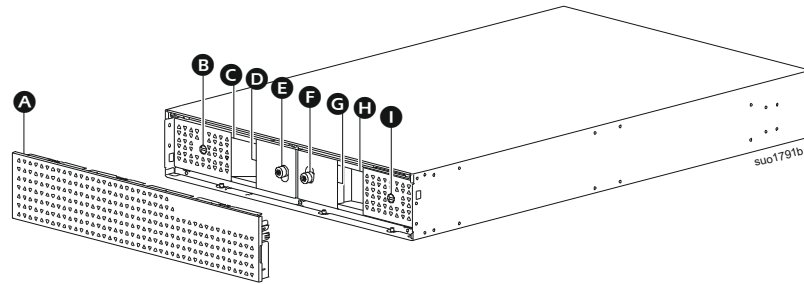

A	Front Bezel
B	BATTERY ON/OFF switch - Left hand (LH) battery module
C	Finger Grip - Left hand (LH) battery module
D	Battery module status LED - Left hand (LH) battery module
E	Thumbscrew - Left hand (LH) battery module
F	Thumbscrew - Right hand (RH) battery module
G	Battery module status LED - Right hand (RH) battery module
H	Finger Grip - Right hand (RH) battery module
I	BATTERY ON/OFF switch - Right hand (RH) battery module

Rear Panel Features

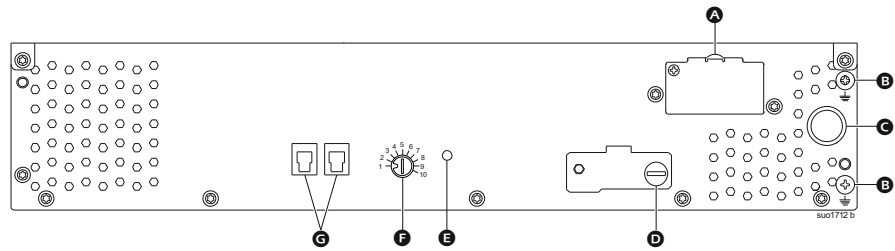

A	Battery receptacle	Connect the battery connection cable from an additional XLBP to this receptacle.
B	Ground terminal	Connect ground wires to this terminal. Refer “Connect the ground cable” on page 10 for details.
C	Battery connection cable	Connect the cable to the battery connection receptacle on the rear panel of the UPS or to another XLBP.
D	XLBP ENABLE switch	Turn the thumbscrew clockwise completely, to enable communication between the XLBP and UPS.
E	XLBP Status LED	Illuminates green to indicate communication status between the XLBP and UPS is enabled.
F	XLBP ID SELECTOR switch†	Set a unique ID for each XLBP connected, using this switch (do not set the same unique ID for multiple XLBPs).
G	Battery communication port	Connect the communication cable from the UPS or from an additional XLBP to this port.

† XLBPs manufactured after August 2023 will have the numbering scheme shown in the illustration.

Installation

Rack-Mount Installation

NOTE:

UPS model SRTL5KRM2UT has been used in the illustrations. The installation process is identical for all UPS models and the respective compatible XLBP models.

Refer to the rail kit installation guide for instructions on rail installation.

Be sure to mount the XLBP in a rack having a minimum depth of 1070 mm.

CAUTION

RISK OF FALLING EQUIPMENT

- The equipment is heavy. Always practice safe lifting techniques adequate for the weight of the equipment.
- Support the RBM with both hands while inserting the RBMs into the XLBP.
- Always use the recommended number of screws to secure brackets to the XLBP.
- Always use the recommended number of screws and cage nuts to secure the XLBP to the rack.
- Always install the XLBP below the UPS in the rack.

Failure to follow these instructions can result in equipment damage and minor or moderate injury.

- 1 Locate the shipping bracket screws. Remove the shipping brackets by unfastening the shipping bracket screws.

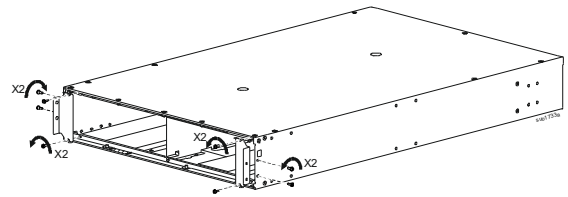

- 2 Secure the brackets and cleats to the XLBP using the screws supplied.

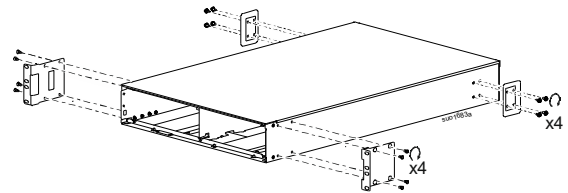

- 3 Slide the XLBP into the rack closure.

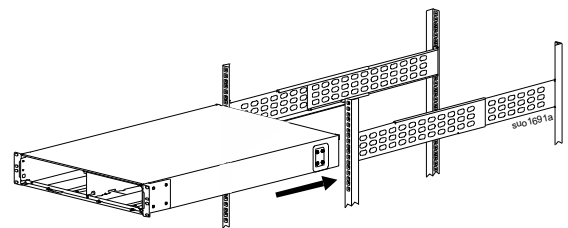

- 4 Secure the XLBP to the rack.

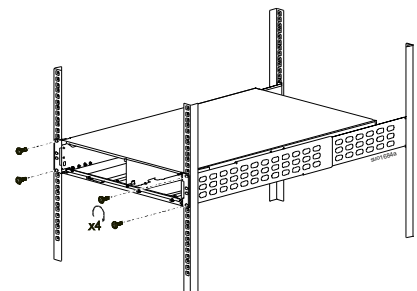

5	<p>1. Slide both the RBMs till they get fully inserted into the XLBP.</p> <p>2. Press the thumbscrew till it engages and turn it clockwise to lock the battery and enable battery communication. Note: If the thumbscrew fails to engage, then push the battery pack further inside the UPS till it gets fully inserted.</p>	
6	<p>Rotate the BATTERY ON/OFF switch counter clockwise, using a screw driver, to turn on the battery pack.</p>	
7	<p>Install the bezel.</p>	

Tower Installation

⚠ CAUTION

RISK OF FALLING EQUIPMENT

- The equipment is heavy. Each battery module weighs 10 kg (approx.).
- Always practice safe lifting techniques adequate for the weight of the equipment.

Failure to follow these instructions can result in equipment damage and minor or moderate injury.

NOTE: UPS model SRTL5KRM2UT has been used in the illustrations. The installation process is identical for all UPS models and the respective compatible XLBP models.

1	<p>Locate hole set B for installing stabilizer brackets to odd numbered XLBPs or hole set A for installing stabilizer brackets to even numbered XLBPs.</p>	
---	--------------------------------------------------------------------------------------------------------------------------------------------------------------------------	--

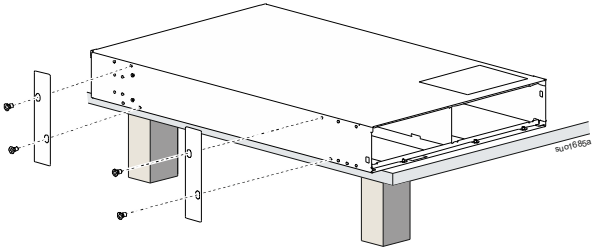
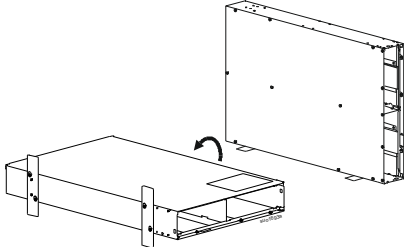
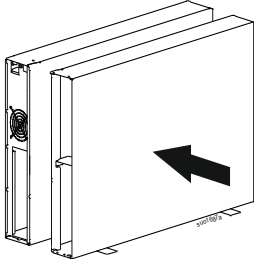
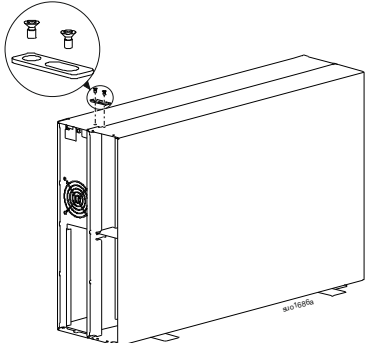
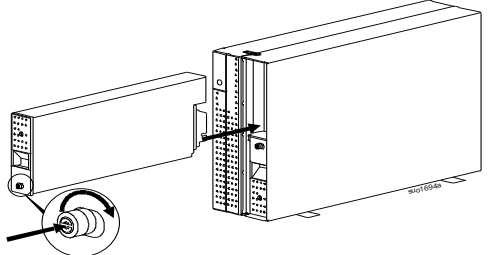
<p>2</p>	<p>Install the stabilizer brackets with the screws supplied.</p>	
<p>3</p>		
<p>4</p>	<p>Place the XLBP beside the UPS by sliding the stabilizer bracket of the XLBP under the UPS.</p>	
<p>5</p>	<p>Secure the UPS and the XLBP with the tie bracket and screws supplied.</p>	
<p>6</p>	<p>1. Slide both the battery packs till they get fully inserted into the UPS. 2. Press the thumbscrew till it engages and turn it clockwise to lock the battery and enable battery communication. Note: If the thumbscrew fails to engage, then push the battery pack further inside the UPS till it gets fully inserted.</p>	

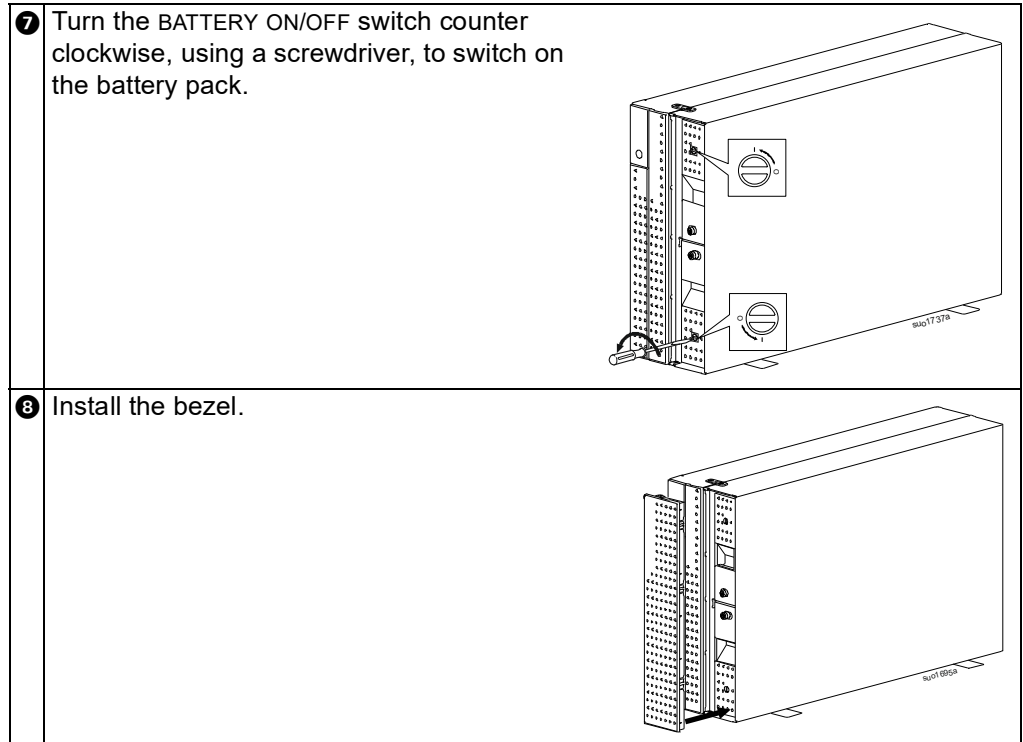

Connect Ground and Battery Cables

NOTE: UPS model SRTL5KRM2UT has been used in the illustrations. The installation process is identical for all UPS models and the respective compatible XLBP models.

Connect the ground cable

1. Locate and remove the ground screw on the rear panel of both the UPS and XLBP.
2. Secure cable lug on one end of the ground wire to the ground terminal on the UPS and the cable lug at the other end to the ground terminal on the XLBP with the screw removed in *step 1*.

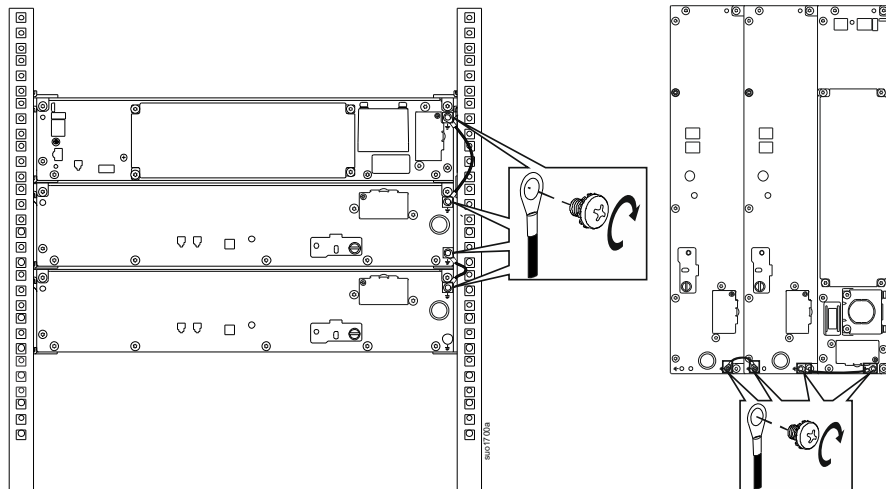

Connect a single XLBP to UPS

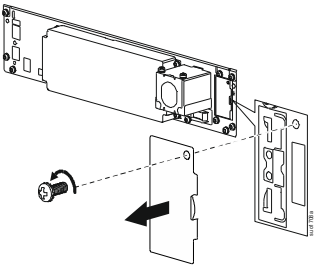
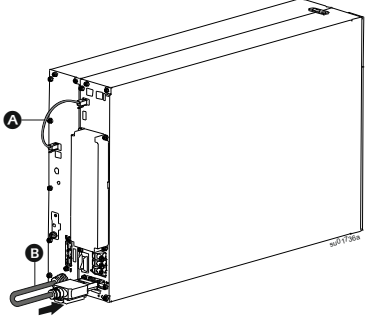
<p>1</p>	<p>Remove the battery receptacle protection cover in the UPS.</p>	
<p>2</p>	<p>Connect the battery communication cable A and battery connector cable B.</p>	

Connect multiple XLBPs to UPS

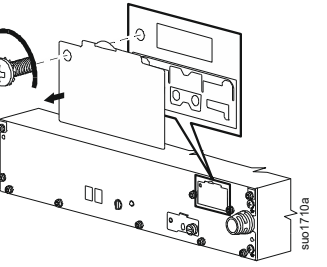
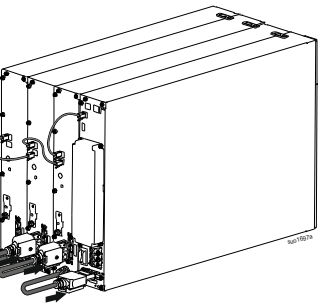
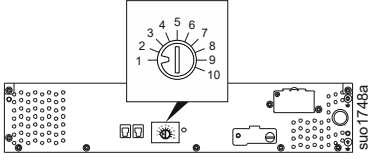
<p>1</p>	<p>Connect the first XLBP to the UPS. Refer “Connect a single XLBP to UPS” on page 11 for details.</p>	
<p>2</p>	<p>Remove the battery receptacle protection cover in the other XLBPs.</p>	
<p>3</p>	<p>Set unique identification (ID) number for each XLBP connected. Set the unique identification (ID) number on the XLBP ID SELECTOR Switch for each XLBP. The position of the notch on the switch dial indicates the set unique ID number. NOTE: Set unique ID for each XLBP.</p>	

Disconnecting the XLBP

Hold the cord provided on the battery connector and pull it towards you. The battery connector will get released from the receptacle, disconnecting the XLBP.

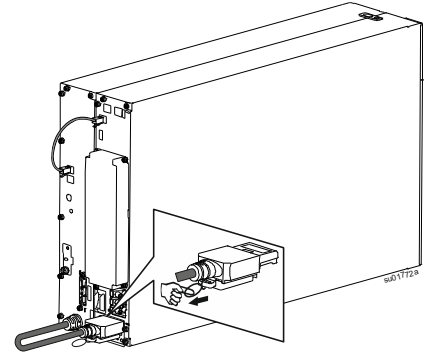

Removing the RBM from XLBP

CAUTION

RISK OF FALLING EQUIPMENT

- The equipment is heavy. Always practice safe lifting techniques adequate for the weight of the equipment.
- Support the RBM with both hands while sliding the RBM out from the XLBP.

Failure to follow these instructions can result in equipment damage and minor or moderate injury.

❶ Remove the front bezel of the XLBP.

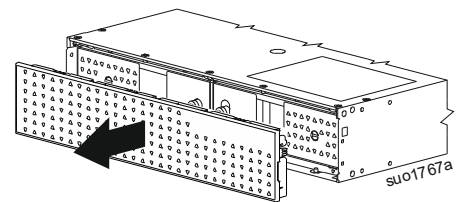

❷ Turn the battery switch in clockwise direction, using a screwdriver, to switch off the battery.

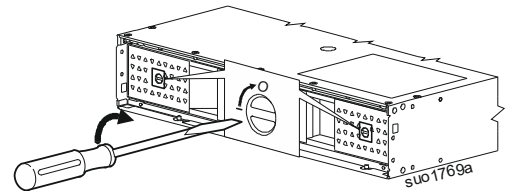

❸ Turn the thumbscrew in counter clockwise direction to unlock the battery module.

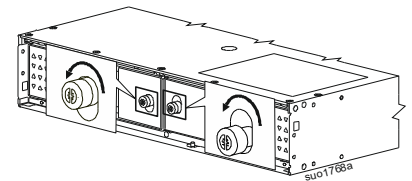

❹ Push and hold the thumbscrew and slide out the battery module using the finger grip provided for the purpose.

- Push downwards for the battery module on the left.
- Push upwards for the battery module on the right.

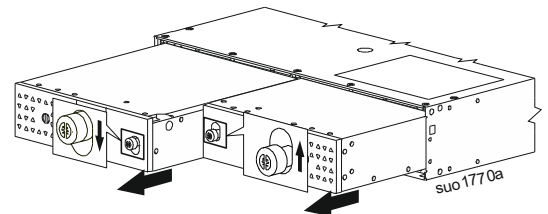

NOTE: Support the battery module while sliding out the RBM from the XLBP.

Smart Battery Management

Definitions

- **Replaceable Battery Module (RBM):** A string of battery cells arranged to produce a battery assembly with a connector. Replacement RBMs can be ordered from our web site, www.apc.com.
- **External Battery Pack (XLBP):** An enclosure that contains RBM(s) and battery management electronics.
- **User Interface (UI):** An interface by which a user can interact with the system. This may include an UPS display interface, a network management interface or PowerChute™ Network Shutdown software.

NOTE: Do not use a battery module that is not approved by Schneider Electric. The system will not detect the presence of a non Schneider Electric approved battery module and may adversely affect the operation of the system. Use of a non Schneider Electric approved battery module will void the manufacturer warranty.

Maintenance

- **RBM maintenance:** The APC RBM uses Lithium ion battery cells and does not require maintenance.
- **Battery health monitoring:** The battery energy output and voltage are monitored to assess the health of the installed batteries when the UPS is operating on battery. Battery health monitoring is done during a UPS **Self Test** when the UPS is operating on battery power.

End of useful life

- **Near end of life notification:** An alert message will appear on the UPS display interface screen when a RBM is approaching the end of its useful life. For configuration details, refer to the UPS Operations Manual. The estimated replacement date for each RBM is available through the UI.
- **Needs replacement notification:** The UPS display interface screen shows when RBM replacement is required. The RBM must be replaced as soon as possible. When an RBM requires replacement, the UPS display interface may recommend that additional RBMs be replaced if they will soon reach the end of their useful life.

NOTE: Continued operation after the Needs replacement notification may cause damage to the batteries.

Recycling the battery module

1. Remove the RBM from the XLBP or the UPS.
2. Recycle the RBM.
CAUTION: Do not disassemble the RBM.

Recommended actions after installing new RBM or XLBP

The following actions should be performed after installing a new RBM or XLBP:

- When a new XLBP is installed, the **Battery status LED** illuminates green in both the RBMs indicating that the XLBP is detected by the system and is working normally.
If **Battery status LED** illuminates either Red or Yellow in any one of the RBMs, refer to “User interface” on page 14 for details.
- Verify that the UPS is connected to input power and output power is turned on.
 - Go to the UPS display interface, use the status menus to verify that the UPS recognizes the RBMs.
 - Be sure that the connected load to the UPS is greater than 400 watts. This information will appear on the UPS display interface.
 - Perform a **Self Test**.
 - If at the time of XLBP installation, UPS input power is not available, turn on the UPS output from battery power for 30 seconds. This will allow the UPS to detect all installed RBMs or XLBPs.
Refer to Operations Manual for details on turning the UPS on and off.
 - Allow the system to charge for 24 hours to ensure full runtime capability.

For details on Self Test refer to the Test and Diagnostics Menu options.

User interface

View Status/Error notifications: The status of connected XLBPs can be viewed using the UPS display interface menu options.

Battery status LED: The **Battery status LED** indicates three possible states.

- **Is not illuminated:** The battery module is in sleep state. This is the default state.
- **Illuminates red:** An internal error has been detected in the RBM.
- **Flashing red:** Battery module unable to communicate with the UPS.
- **Illuminates green:** Battery module operating normally.
- **Illuminates yellow:** Check the LCD display. If the battery mode icon is displayed on the LCD display, then the battery is discharging. Otherwise, an internal error in the RBM has been detected.

To clear the detected internal error,

1. Disconnect RBM by disengaging the thumbscrew (located on the front panel of the RBM).
2. Be sure that **Battery status LED** is not illuminating.
3. Tighten the thumbscrew to connect the RBM.

NOTE: If the problem persists even after 3 attempts, then contact APC Customer Support.

System interfaces: Battery status, alerts, and measurements are shown on the UPS display interface screen.

Replace the RBM in XLBP

A RBM should only be disconnected or removed from the XLBP temporarily as part of the battery replacement procedure.

1. Refer to “Removing the RBM from XLBP” on page 12 for details
2. After installing the RBM, the UPS display interface may prompt the user to verify the status of the replaced battery modules. If the battery module is new, respond YES. If the battery module is not new, respond NO.

Troubleshooting

Issues	Possible Cause	Solution
XLBP Status LED illuminates Red.	Potential hardware error detected.	<ol style="list-style-type: none"> 1. Remove the battery cable connector from the battery cable receptacle. 2. Re-connect the battery cable connector to the battery cable receptacle. If the issue still persists, contact APC customer support.
Battery module status LED and XLBP status LED do not illuminate	XLBP ENABLE switch is turned <i>off</i> (thumbscrew loosened)	Be sure that the XLBP ENABLE switch is turned on (thumbscrew is tightened completely).

Limited Factory Warranty

Schneider Electric IT Corporation (SEIT), warrants its products to be free from defects in materials and workmanship for a period of five (5) years from the date of purchase. SEIT obligation under this warranty is limited to repairing or replacing, at its own sole option, any such defective products. Repair or replacement of a defective product or parts thereof does not extend the original warranty period.

This warranty applies only to the original purchaser who must have properly registered the product within 10 days of purchase. Products may be registered online at warranty.apc.com.

SEIT shall not be liable under the warranty if its testing and examination disclose that the alleged defect in the product does not exist or was caused by end user or any third person misuse, negligence, improper installation, testing, operation or use of the product contrary to SEIT recommendations or specifications. Further, SEIT shall not be liable for defects resulting from: 1) unauthorized attempts to repair or modify the product, 2) incorrect or inadequate electrical voltage or connection, 3) inappropriate on site operation conditions, 4) Acts of God, 5) exposure to the elements, or 6) theft. In no event shall SEIT have any liability under this warranty for any product where the serial number has been altered, defaced, or removed.

EXCEPT AS SET FORTH ABOVE, THERE ARE NO WARRANTIES, EXPRESS OR IMPLIED, BY OPERATION OF LAW OR OTHERWISE, APPLICABLE TO PRODUCTS SOLD, SERVICED OR FURNISHED UNDER THIS AGREEMENT OR IN CONNECTION HEREWITH.

SEIT DISCLAIMS ALL IMPLIED WARRANTIES OF MERCHANTABILITY, SATISFACTION AND FITNESS FOR A PARTICULAR PURPOSE.

SEIT EXPRESS WARRANTIES WILL NOT BE ENLARGED, DIMINISHED, OR AFFECTED BY AND NO OBLIGATION OR LIABILITY WILL ARISE OUT OF, SEIT RENDERING OF TECHNICAL OR OTHER ADVICE OR SERVICE IN CONNECTION WITH THE PRODUCTS.

THE FOREGOING WARRANTIES AND REMEDIES ARE EXCLUSIVE AND IN LIEU OF ALL OTHER WARRANTIES AND REMEDIES. THE WARRANTIES SET FORTH ABOVE CONSTITUTE SEIT'S SOLE LIABILITY AND PURCHASER EXCLUSIVE REMEDY FOR ANY BREACH OF SUCH WARRANTIES. SEIT WARRANTIES EXTEND ONLY TO ORIGINAL PURCHASER AND ARE NOT EXTENDED TO ANY THIRD PARTIES.

IN NO EVENT SHALL SEIT, ITS OFFICERS, DIRECTORS, AFFILIATES OR EMPLOYEES BE LIABLE FOR ANY FORM OF INDIRECT, SPECIAL, CONSEQUENTIAL OR PUNITIVE DAMAGES, ARISING OUT OF THE USE, SERVICE OR INSTALLATION OF THE PRODUCTS, WHETHER SUCH DAMAGES ARISE IN CONTRACT OR TORT, IRRESPECTIVE OF FAULT, NEGLIGENCE OR STRICT LIABILITY OR WHETHER SEIT HAS BEEN ADVISED IN ADVANCE OF THE POSSIBILITY OF SUCH DAMAGES. SPECIFICALLY, SEIT IS NOT LIABLE FOR ANY COSTS, SUCH AS LOST PROFITS OR REVENUE, WHETHER DIRECT OR INDIRECT, LOSS OF EQUIPMENT, LOSS OF USE OF EQUIPMENT, LOSS OF SOFTWARE, LOSS OF DATA, COSTS OF SUBSTITUANTS, CLAIMS BY THIRD PARTIES, OR OTHERWISE.

NOTHING IN THIS LIMITED WARRANTY SHALL SEEK TO EXCLUDE OR LIMIT SEIT LIABILITY FOR DEATH OR PERSONAL INJURY RESULTING FROM ITS NEGLIGENCE OR ITS FRAUDULENT MISREPRESENTATION OF TO THE EXTENT THAT IT CANNOT BE EXCLUDED OR LIMITED BY APPLICABLE LAW.

To obtain service under warranty you must obtain a Returned Material Authorization (RMA) number from customer support. Customers with warranty claims issues may access the SEIT worldwide customer support network through our web site: **www.apc.com**. Select your country from the country selection drop down menu. Open the Support tab at the top of the web page to obtain information for customer support in your region. Products must be returned with transportation charges prepaid and must be accompanied by a brief description of the problem encountered and proof of date and place of purchase.

APC Worldwide Customer Support

Customer support for this or any other APC product is available at no charge in any of the following ways:

- Visit our web site to access documents in the APC Knowledge Base and to submit customer support requests.
 - **www.apc.com** (Corporate Headquarters)
Connect to localized web sites for specific countries, each of which provides customer support information.
 - **www.apc.com/support/**
Global support searching APC Knowledge Base and using e-support.
- Contact APC Customer Support Center by telephone or e-mail.
 - Local, country specific centers: go to **www.apc.com/support/contact** for contact information.
 - For information on how to obtain local customer support, contact APC representative or other distributor from whom you purchased your APC product.